

# REF1004

## 1.2V and 2.5V Micropower VOLTAGE REFERENCE

### FEATURES

- **INITIAL ACCURACY:**  
REF1004-1.2  $\pm 4\text{mV}$   
REF1004-2.5  $\pm 20\text{mV}$
- **MINIMUM OPERATING CURRENT:**  
REF1004-1.2  $10\mu\text{A}$   
REF1004-2.5  $20\mu\text{A}$
- **EXCELLENT LONG TERM TEMPERATURE STABILITY**
- **VERY LOW DYNAMIC IMPEDANCE**
- **OPERATES UP TO 20mA**
- **PACKAGE: 8-Lead SOIC**

### APPLICATIONS

- **BATTERY POWERED TEST EQUIPMENT**
- **PORTABLE MEDICAL INSTRUMENTATION**
- **PORTABLE COMMUNICATIONS DEVICES**
- **A/D AND D/A CONVERTERS**
- **NOTEBOOK AND PALMTOP COMPUTERS**

### DESCRIPTION

The REF1004-1.2 and REF1004-2.5 are two terminal bandgap reference diodes designed for high accuracy with outstanding temperature characteristics at low operating currents. Prior to the introduction of the REF1004 Micropower Voltage References, accuracy and stability specifications could only be attained by expensive screening of standard devices. The REF1004 is a cost effective solution when reference voltage accuracy, low power, and long term temperature stability are required.

REF1004 is a drop-in replacement for the LT1004 as well as an upgraded replacement of the LM185/385 series references. The REF1004C is characterized for operation from  $0^{\circ}\text{C}$  to  $70^{\circ}\text{C}$  and the REF1004I is characterized for operation from  $-40^{\circ}\text{C}$  to  $+85^{\circ}\text{C}$ .

The REF1004 is offered in an 8-lead Plastic SOIC package and shipped in anti-static rails or tape and reel.

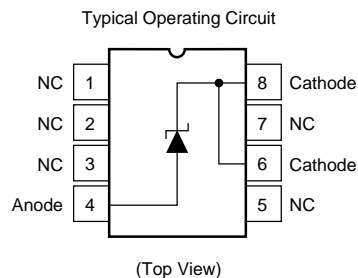

International Airport Industrial Park • Mailing Address: PO Box 11400 • Tucson, AZ 85734 • Street Address: 6730 S. Tucson Blvd. • Tucson, AZ 85706  
Tel: (520) 746-1111 • Twx: 910-952-1111 • Cable: BBRCORP • Telex: 066-6491 • FAX: (520) 889-1510 • Immediate Product Info: (800) 548-6132

# SPECIFICATIONS

## ELECTRICAL

T<sub>A</sub> = +25°C unless otherwise noted.

PARAMETER	CONDITIONS	REF1004-1.2			REF1004-2.5			UNITS
		MIN	TYP	MAX	MIN	TYP	MAX	
REFERENCE VOLTAGE REF1004C <sup>(1)</sup> REF1004I <sup>(2)</sup>	I <sub>R</sub> = 100μA	1.231 1.229 1.225	1.235 1.235 1.235	1.239 1.239 1.239	2.490 2.487 2.480	2.500 2.500 2.500	2.511 2.511 2.511	V
AVERAGE TEMPERATURE COEFFICIENT	I <sub>MIN</sub> ≤ I <sub>R</sub> ≤ 20mA		20			20		ppm/°C
MINIMUM OPERATION CURRENT <sup>(3)</sup>			8	10		12	20	μA
REVERSE BREAKDOWN VOLTAGE CHANGE WITH CURRENT	I <sub>MIN</sub> ≤ I <sub>R</sub> ≤ 1mA 1mA ≤ I <sub>R</sub> ≤ 20mA			1 1.5 <sup>(3)</sup> 10 20 <sup>(3)</sup>			1 1.5 <sup>(3)</sup> 10 20 <sup>(3)</sup>	mV
REVERSE DYNAMIC IMPEDANCE <sup>(3)</sup>	I <sub>R</sub> = 100μA		0.2	0.6		0.2	0.6	Ω
WIDE BAND NOISE (RMS) 10Hz ≤ I <sub>R</sub> ≤ 10kHz	I <sub>R</sub> = 100μA		60			120		μV
LONG TERM STABILITY T <sub>A</sub> = 25°C ± 0.1°C	I <sub>R</sub> = 100μA		20			20		ppm/KHr

NOTES: (1) This specification applies over the full operating temperature range of 0°C ≤ T<sub>A</sub> ≤ 70°C. (2) This specification applies over the full operating temperature range of 40°C ≤ T<sub>A</sub> ≤ +85°C. (3) Denotes the specifications which apply over the full operating temperature range.

## ORDERING INFORMATION

MODEL	T <sub>A</sub>	V <sub>Z</sub>	PACKAGE
REF1004C-1.2	0°C to +70°C	1.2V	8-Lead SOIC
REF1004C-2.5	0°C to +70°C	2.5V	8-Lead SOIC
REF1004I-1.2	-40°C to +85°C	1.2V	8-Lead SOIC
REF1004I-2.5	-40°C to +85°C	2.5V	8-Lead SOIC

NOTE: Available in Tape and Reel, Add -TR to Model Number.

## ABSOLUTE MAXIMUM RATINGS

Reverse Breakdown Current	30mA
Forward Current	10mA
Operating Temperature Range	
REF1004C	0°C to +70°C
REF1004I	-40°C to +85°C
Storage Temperature	
REF1004C	-65°C to +150°C
REF1004I	-65°C to +150°C
Lead Temperature (soldering, 10s)	+300°C

## ORDERING INFORMATION

MODEL	PART MARKING
REF1004C-1.2	BBREF0412
REF1004C-2.5	BBREF0425
REF1004I-1.2	BBREF0412
REF1004I-2.5	BBREF0425

## PACKAGE INFORMATION

MODEL	PACKAGE	PACKAGE DRAWING NUMBER <sup>(1)</sup>
REF1004C-1.2	8-Pin SOIC	182
REF1004C-2.5	8-Pin SOIC	182
REF1004I-1.2	8-Pin SOIC	182
REF1004I-2.5	8-Pin SOIC	182

NOTE: (1) For detailed drawing and dimension table, please see end of data sheet, or Appendix D of Burr-Brown IC Data Book.

The information provided herein is believed to be reliable; however, BURR-BROWN assumes no responsibility for inaccuracies or omissions. BURR-BROWN assumes no responsibility for the use of this information, and all use of such information shall be entirely at the user's own risk. Prices and specifications are subject to change without notice. No patent rights or licenses to any of the circuits described herein are implied or granted to any third party. BURR-BROWN does not authorize or warrant any BURR-BROWN product for use in life support devices and/or systems.



REF1004

# TYPICAL PERFORMANCE CURVES 1.2V

$T_A = +25^\circ\text{C}$  unless otherwise noted.

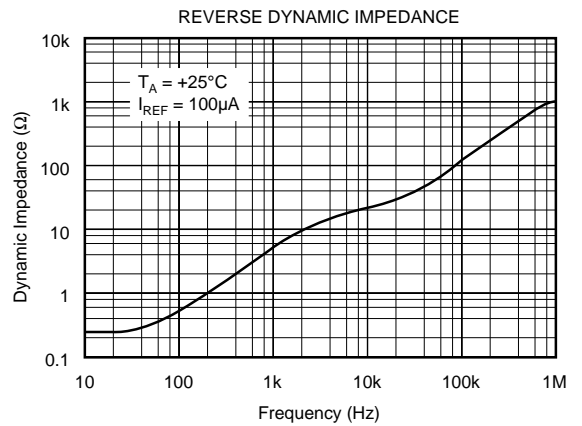
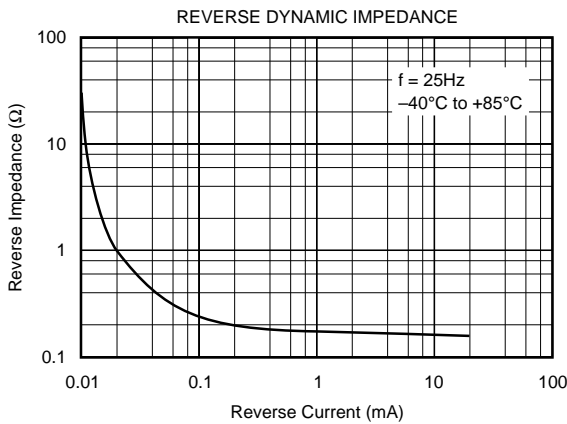
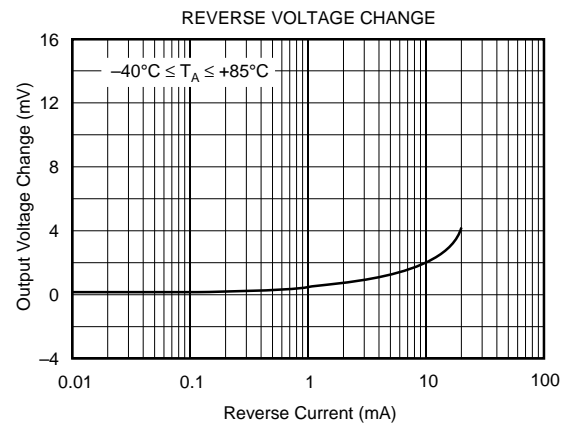
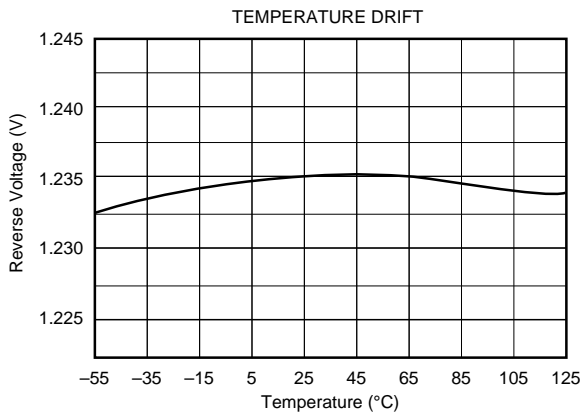
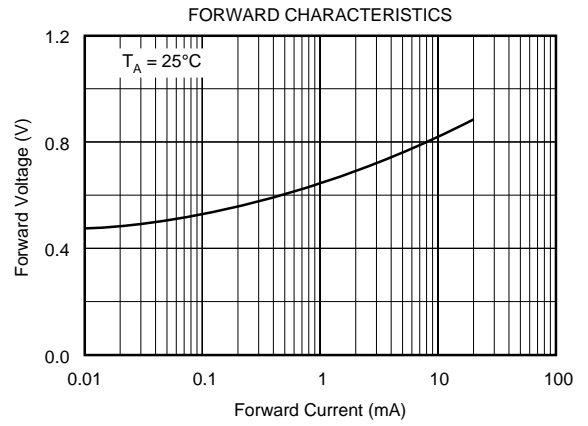
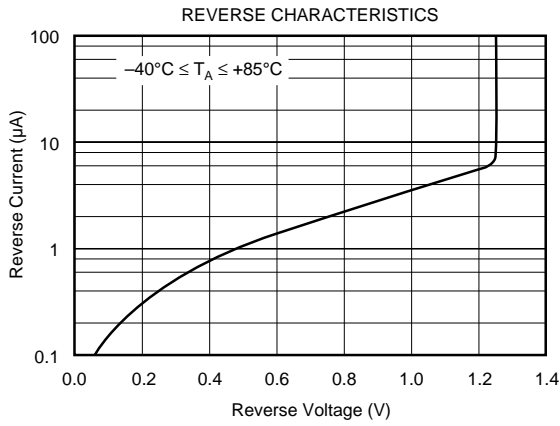

# TYPICAL PERFORMANCE CURVES 1.2V (CONT)

$T_A = +25^\circ\text{C}$  unless otherwise noted.

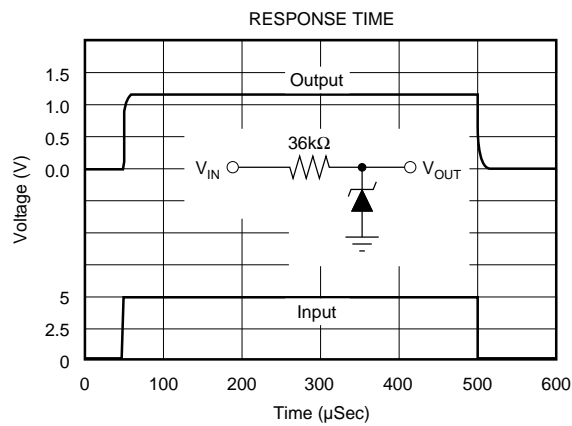
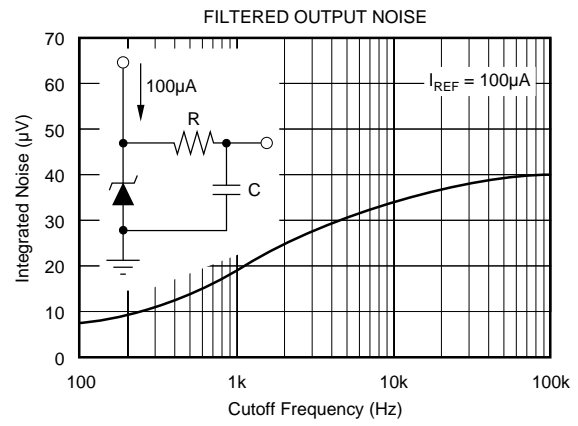
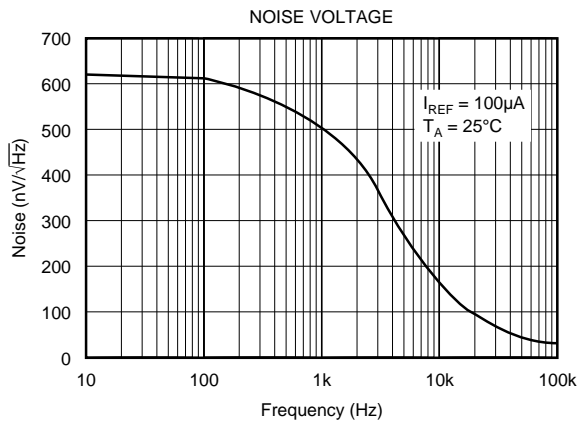

# TYPICAL PERFORMANCE CURVES 2.5V

$T_A = +25^\circ\text{C}$  unless otherwise noted.

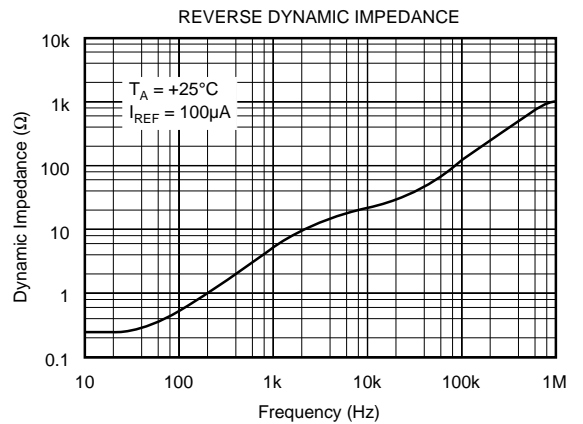
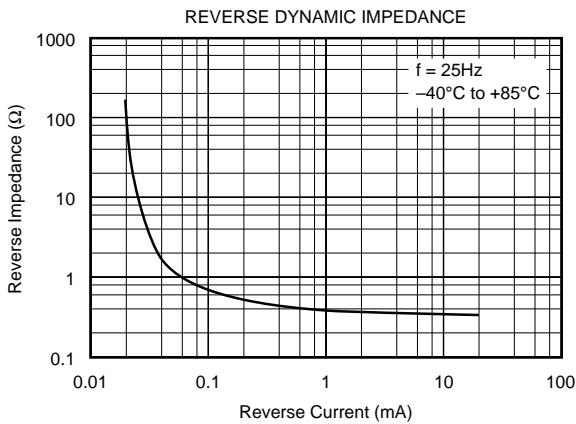
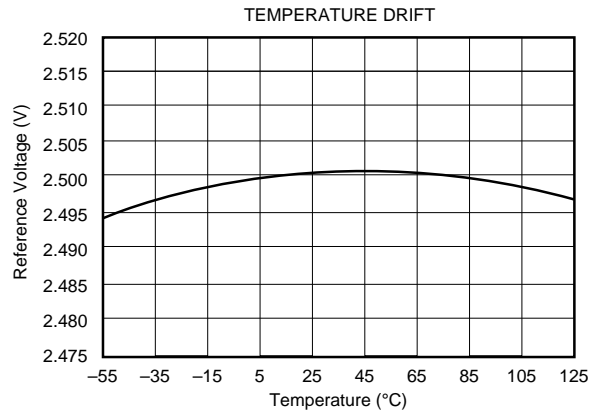
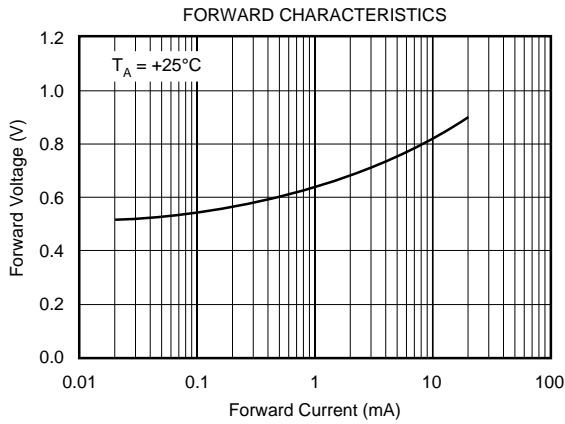
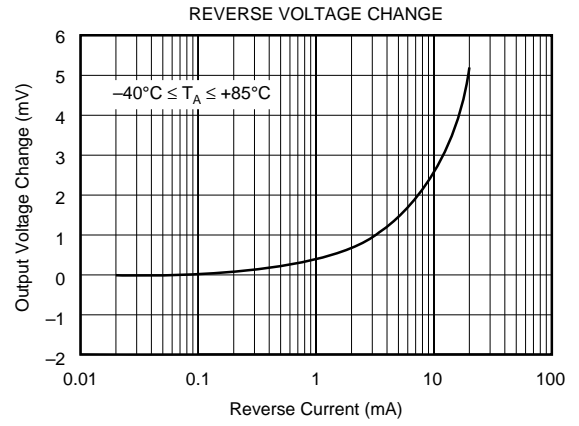
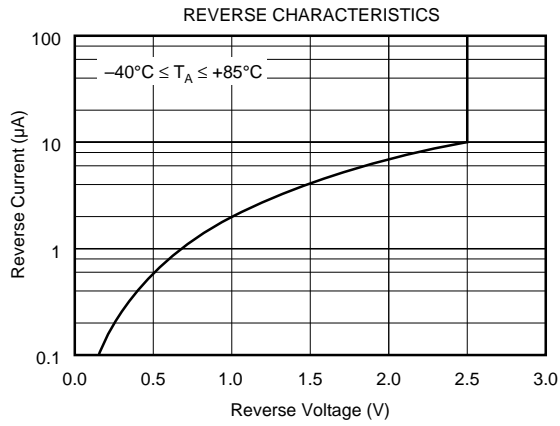

# TYPICAL PERFORMANCE CURVES 2.5V (CONT)

T<sub>A</sub> = +25°C unless otherwise noted.

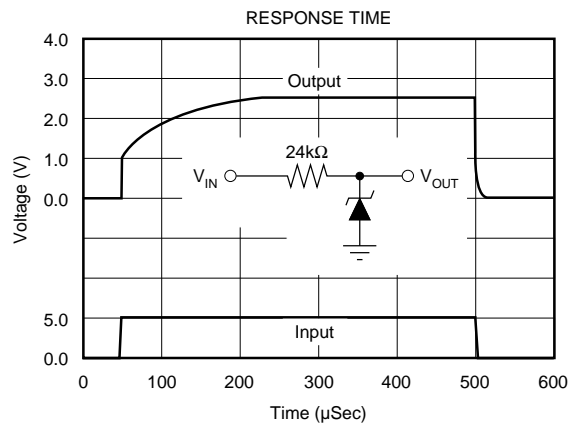
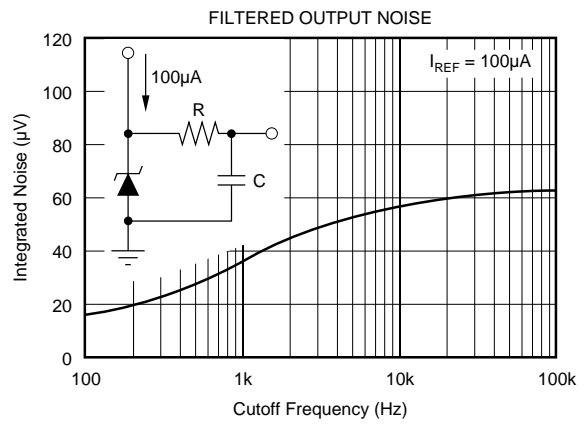
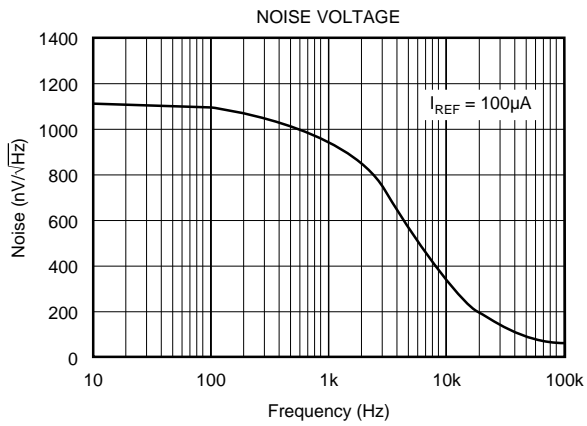

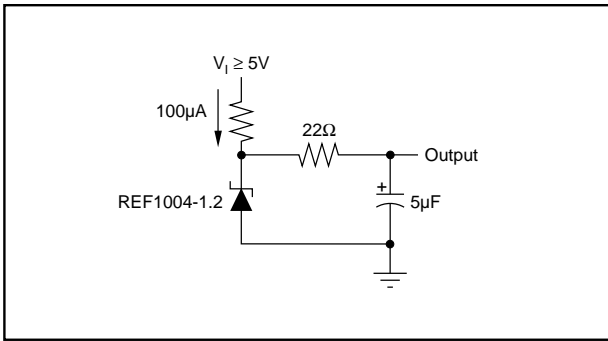

FIGURE 1. Low-Noise Reference.

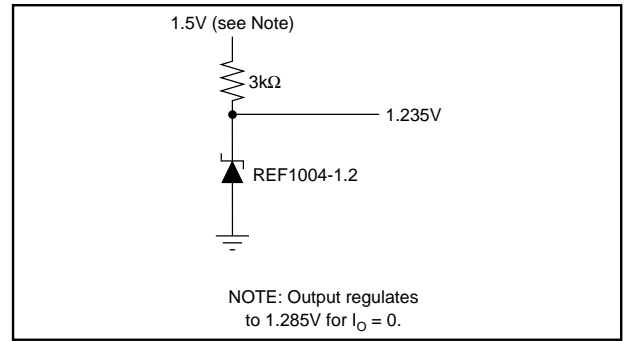

FIGURE 3. 1.2V Reference from 1.5V Battery.

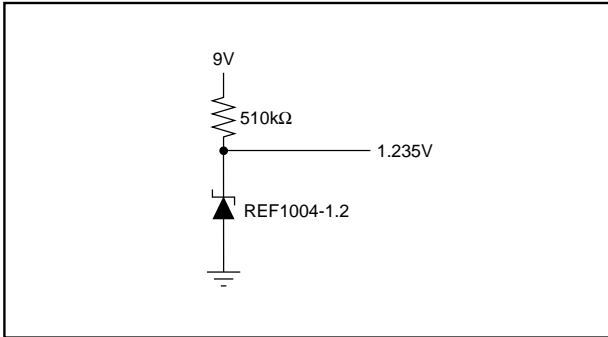

FIGURE 2. Micropower Reference from 9V Battery.

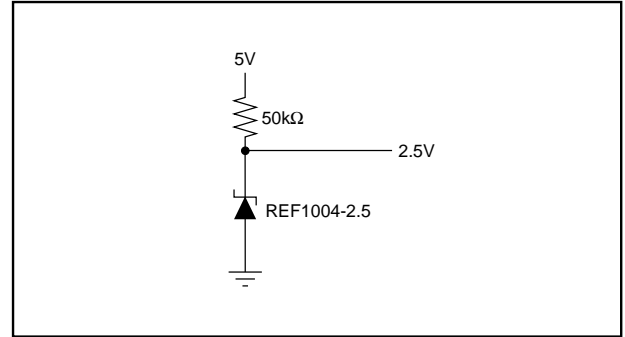

FIGURE 4. 2.5V Reference.

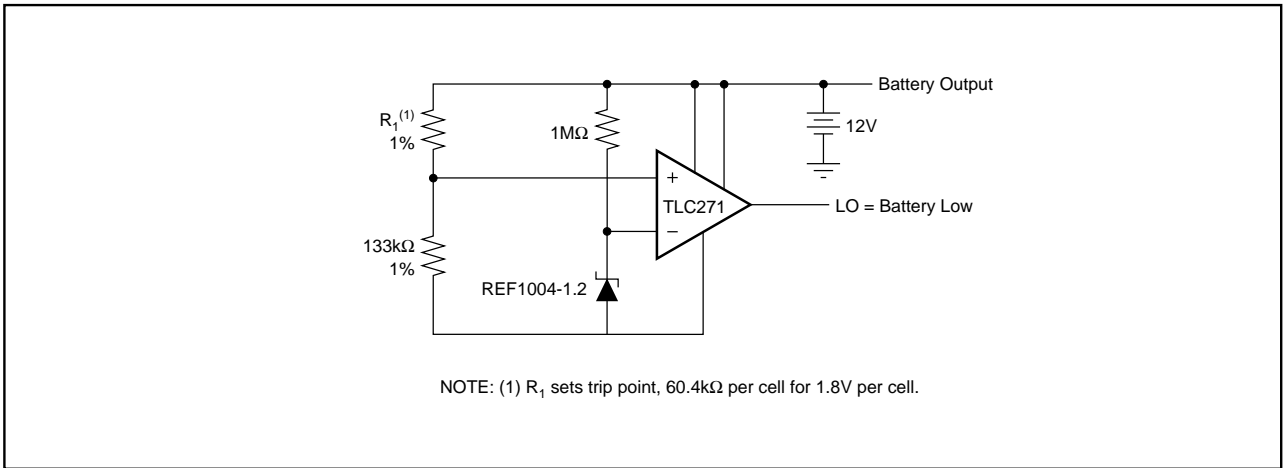

FIGURE 5. Lead-Acid Low-Battery-Voltage Detector.