

DUAL CHANNEL ILD621/621GB QUAD CHANNEL ILQ621/621GB MULTI-CHANNEL PHOTOTRANSISTOR OPTOCOUPLER

FEATURES

- Alternate Source to TLP621-2/-4 and TLP621GB-2/-4
- Current Transfer Ratio (CTR) at $I_F = 5 \text{ mA}$
ILD/Q621: 50% Min.
ILD/Q621GB: 100% Min.
- Saturated Current Transfer Ratio (CTR_{SAT}) at $I_F = 1 \text{ mA}$
ILD/Q621: 60% Typ.
ILD/Q621GB: 30% Min.
- High Collector-Emitter Voltage, $BV_{CEO} = 70 \text{ V}$
- Dual and Quad Packages Feature:
 - Reduced Board Space
 - Lower Pin and Parts Count
 - Better Channel to Channel CTR Match
 - Improved Common Mode Rejection
- Field-Effect Stable by TRIOS (TRansparent IOn Shield)
- Isolation Test Voltage from Double Molded Package, 5300 VAC_{RMS}
- Underwriters Lab File #E52744
- VDE 0884 Available with Option 1

Maximum Ratings (Each Channel)

Emitter

Reverse Voltage	6 V
Forward Current	60 mA
Surge Current	1.5 A
Power Dissipation.....	100 mW
Derate from 25°C	1.33 mW/°C

Detector

Collector-Emitter Reverse Voltage	70 V
Collector Current.....	50 mA
Collector Current ($t < 1 \text{ ms}$).....	100 mA
Power Dissipation.....	150 mW
Derate from 25°C	-2 mW/°C

Package

Isolation Test Voltage	
($t = 1 \text{ sec.}$)	7500 VAC _{PK}
($t = 1 \text{ min.}$)	5300 VAC _{RMS}
Package Dissipation ILD620/GB.....	400 mW
Derate from 25°C	5.33 mW/°C
Package Dissipation ILQ620/GB	500 mW
Derate from 25°C	6.67 mW/°C
Creepage	7 mm min.
Clearance.....	7 mm min.
Isolation Resistance	
$V_{IO} = 500 \text{ V}, T_A = 25^\circ\text{C}$	$\geq 10^{12} \Omega$
$V_{IO} = 500 \text{ V}, T_A = 100^\circ\text{C}$	$\geq 10^{11} \Omega$
Storage Temperature.....	-55°C to +150°C
Operating Temperature	-55°C to +100°C
Junction Temperature.....	100°C
Soldering Temperature	
(2 mm from case bottom).....	260°C

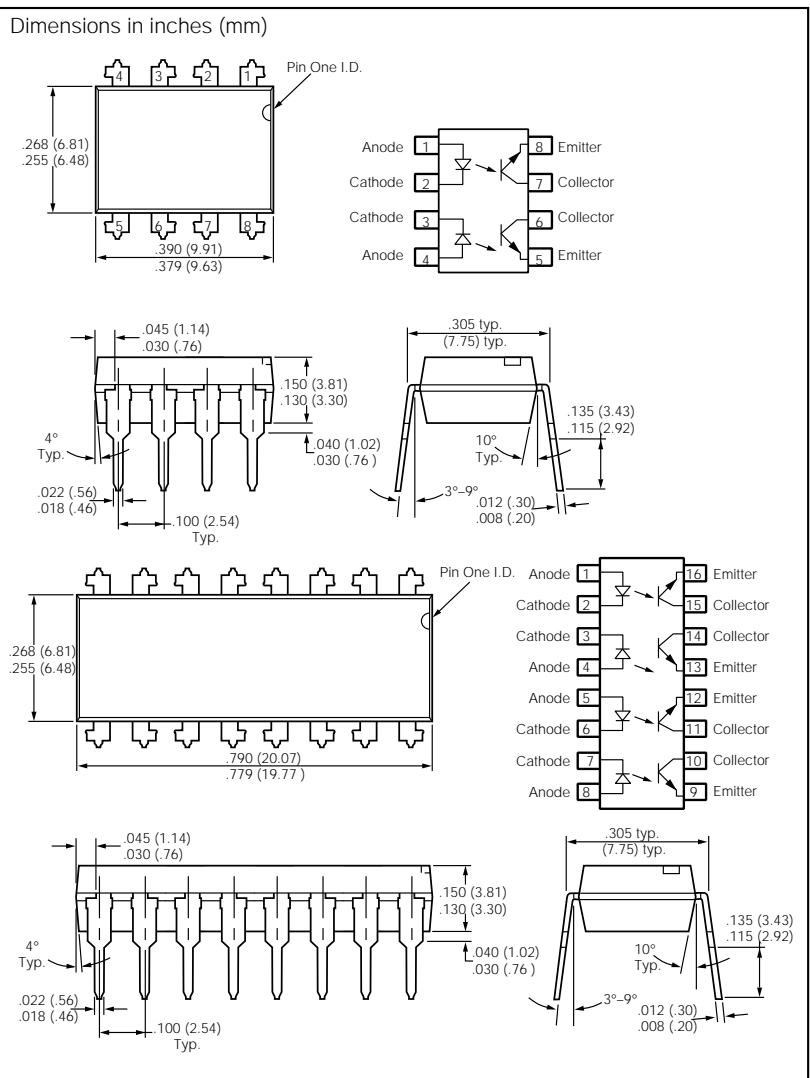

DESCRIPTION

The ILD/Q621 and ILD/Q621GB are multi-channel phototransistor optocouplers that use GaAs IRLED emitters and high gain NPN silicon phototransistors. These devices are constructed using over/under leadframe optical coupling and double molded insulation technology. This assembly process offers a withstand test voltage of 7500 VDC.

The ILD/Q621GB is well suited for CMOS interfacing given the CTR_{CESat} of 30% minimum at I_F of 1 mA. High gain linear operation is guaranteed by a minimum CTR_{CE} of 100% at 5 mA. The ILD/Q621 has a guaranteed CTR_{CE} of 50% minimum at 5 mA. The TRansparent IOn Shield insures stable DC gain in applications such as power supply feedback circuits, where constant DC V_{IO} voltages are present.

Characteristics

	Symbol	Min.	Typ.	Max.	Unit	Condition
Emitter						
Forward Voltage	V_F	1	1.15	1.3	V	$I_F=10\text{ mA}$
Reverse Current	I_R		0.01	10	μA	$V_R=6\text{ V}$
Capacitance	C_O		40		pF	$V_F=0\text{ V}$, $f=1\text{ MHz}$
Thermal Resistance, Junction to Lead	R_{THJL}		750		$^{\circ}\text{C/W}$	
Detector						
Capacitance	C_{CE}		6.8		pF	$V_{CE}=5\text{ V}$, $f=1\text{ MHz}$
Collector-Emitter Leakage Current	I_{CEO}		10	100	nA	$V_{CE}=24\text{ V}$
Collector-Emitter Leakage Current	I_{CEO}		2	50	μA	$T_A=85^{\circ}\text{C}$, $V_{CE}=24\text{ V}$
Thermal Resistance, Junction to Lead	R_{THJL}		500		$^{\circ}\text{C/W}$	
Package Transfer Characteristics						
Channel/Channel CTR Match	CTRX/CTRY	1 to 1		3 to 1		$I_F=5\text{ mA}$, $V_{CE}=5\text{ V}$
ILD/Q621						
Saturated Current Transfer Ratio	CTR_{CEsat}		60		%	$I_F=1\text{ mA}$, $V_{CE}=0.4\text{ V}$
Current Transfer Ratio	CTR_{CE}	50	80	600	%	$I_F=5\text{ mA}$, $V_{CE}=5\text{ V}$
Collector-Emitter Saturation Voltage	V_{CEsat}			0.4	V	$I_F=8\text{ mA}$, $I_{CE}=2.4\text{ mA}$
ILD/Q621GB						
Saturated Current Transfer Ratio	CTR_{CEsat}	30			%	$I_F=1\text{ mA}$, $V_{CE}=0.4\text{ V}$
Current Transfer Ratio (Collector-Emitter)	CTR_{CE}	100	200	600	%	$I_F=5\text{ mA}$, $V_{CE}=5\text{ V}$
Collector-Emitter Saturation Voltage	V_{CEsat}			0.4	V	$I_F=8\text{ mA}$, $I_{CE}=0.2\text{ mA}$
Isolation and Insulation						
Common Mode Rejection, Output High	CMH		5000		V/ μs	$V_{CM}=50\text{ V}_{P-P}$, $R_L=1\text{ k}\Omega$, $I_F=0\text{ mA}$
Common Mode Rejection, Output Low	CML		5000		V/ μs	$V_{CM}=50\text{ V}_{P-P}$, $R_L=1\text{ k}\Omega$, $I_F=10\text{ mA}$
Common Mode Coupling Capacitance	C_{CM}		0.01		pF	
Package Capacitance	CI-O	0.8			pF	$V_{IO}=0\text{ V}$, $f=1\text{ MHz}$
Insulation Resistance	R_S	10^{12}			Ω	$V_{IO}=500\text{ V}$, $T_A=25^{\circ}\text{C}$
Channel to Channel Insulation		500			VAC	

Switching Times

Figure 1. Non-saturated switching timing

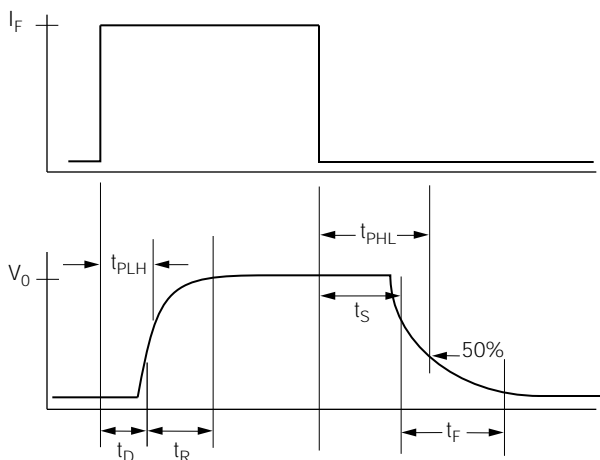
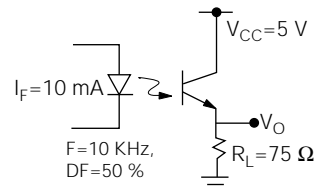

Figure 2. Non-saturated switching timing



Characteristic	Symbol	Typ.	Unit	Test Condition
On Time	T_{ON}	3.0	μs	$I_F=\pm 10\text{ mA}$
Rise Time	t_R	20	μs	$V_{CC}=5\text{ V}$
Off Time	t_{OFF}	2.3	μs	$R_L=75\ \Omega$
Fall Time	t_F	2.0	μs	50% of V_{PP}
Propagation H-L	t_{PHL}	1.1	μs	
Propagation L-H	t_{PLH}	2.5	μs	

Figure 3. Saturated switching timing

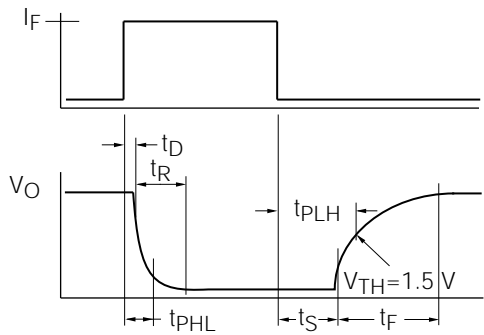
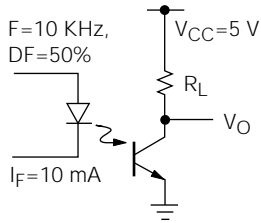

Figure 4. Saturated switching timing



Characteristic	Symbol	Typ.	Unit	Test Condition
On Time	T_{ON}	4.3	μs	$I_F = \pm 10 \text{ mA}$
Rise Time	t_R	2.8	μs	$V_{CC} = 5 \text{ V}$
Off Time	t_{OFF}	2.5	μs	$R_L = 1 \Omega$
Fall Time	t_F	11	μs	$V_{TH} = 1.5 \text{ V}$
Propagation H-L	t_{PHL}	2.6	μs	
Propagation L-H	t_{PLH}	7.2	μs	

Figure 5. Maximum LED current versus ambient temperature

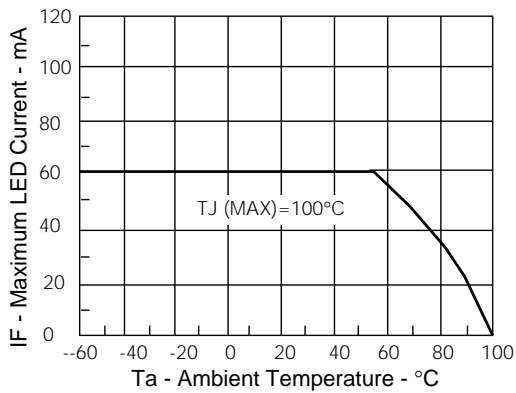

Figure 6. Maximum LED power dissipation

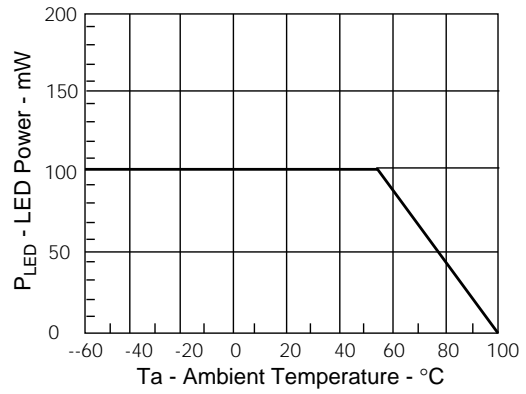

Figure 7. Forward voltage versus forward current

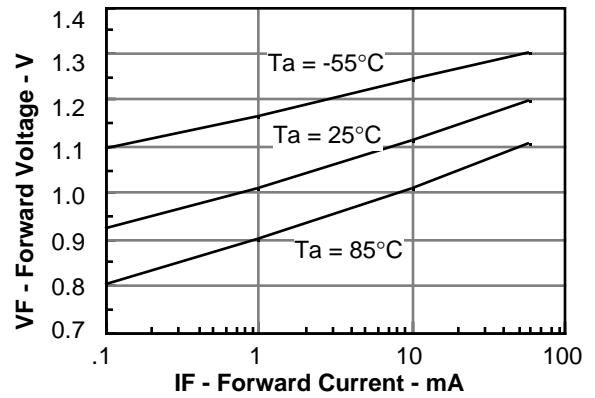

Figure 8. Collector-emitter current versus temperature and LED current

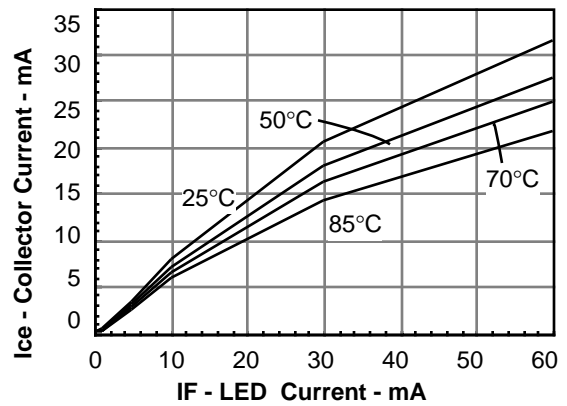

Figure 9. Collector-emitter leakage versus temperature

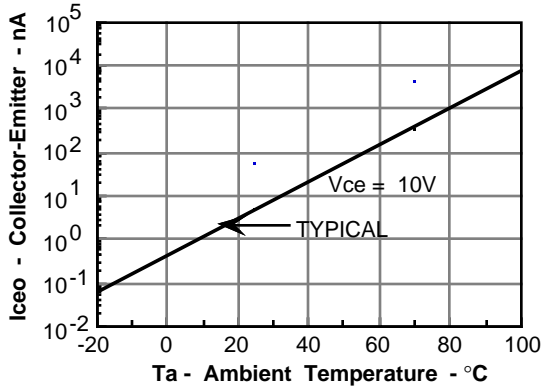

Figure 10. Propagation delay versus collector load resistor

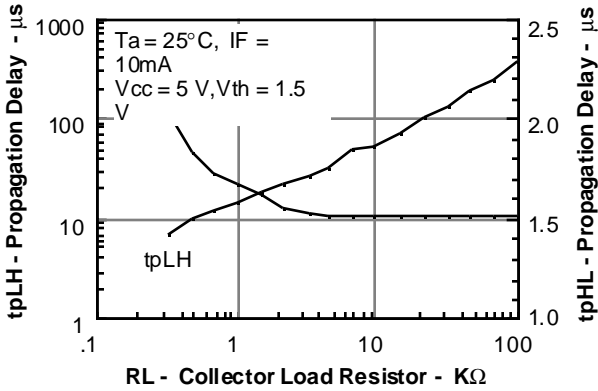

Figure 11. Maximum detector power dissipation

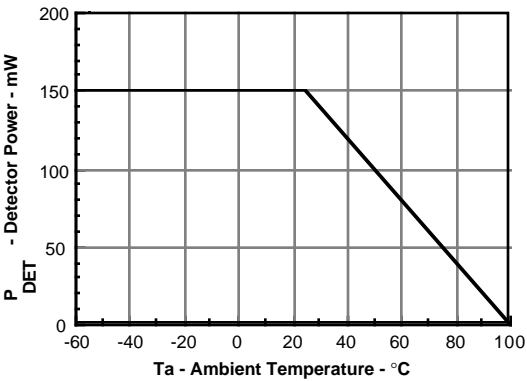

Figure 12. Maximum collector current versus collector voltage

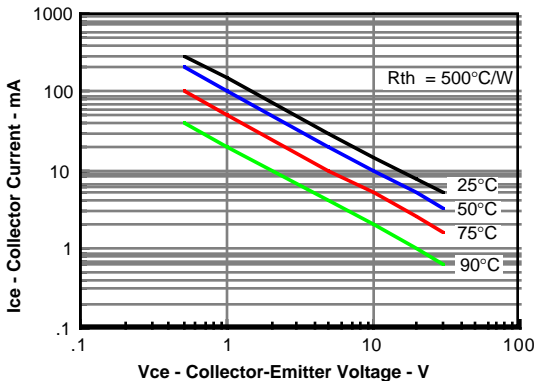

Figure 13. Normalization factor for non-saturated and saturated CTR $T_A=50^{\circ}C$ versus I_f

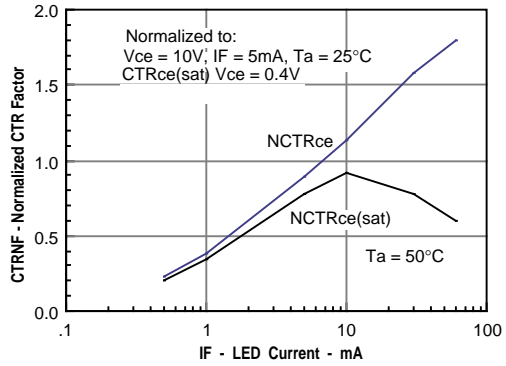

Figure 14. Normalization factor for non-saturated and saturated CTR $T_A=70^{\circ}C$ versus I_f

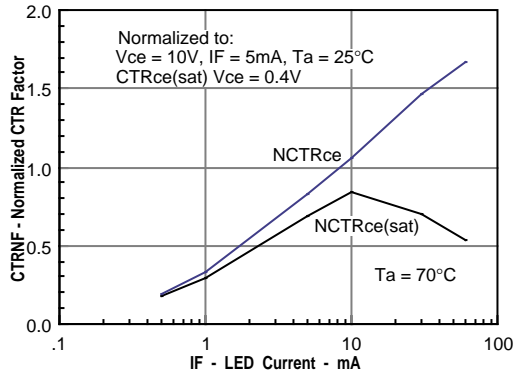

Figure 15. Normalization factor for non-saturated and saturated CTR $T_A=100^{\circ}C$ versus I_f

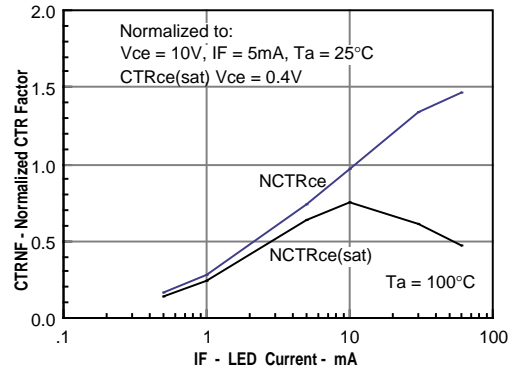
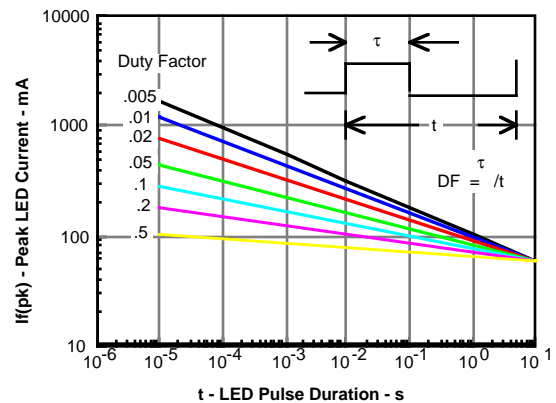

Figure 16. Peak LED current versus pulse duration, Tau



This datasheet has been download from:

www.datasheetcatalog.com

Datasheets for electronics components.