

## Standard 7– Segment Display 10 mm

| Color      | Type     | Circuitry      |
|------------|----------|----------------|
| Red        | TDSR315. | Common anode   |
| Red        | TDSR316. | Common cathode |
| Orange red | TDSO315. | Common anode   |
| Orange red | TDSO316. | Common cathode |
| Yellow     | TDSY315. | Common anode   |
| Yellow     | TDSY316. | Common cathode |
| Green      | TDSG315. | Common anode   |
| Green      | TDSG316. | Common cathode |

### Description

The TDS.31.. series are 10 mm character seven segment LED displays in a very compact package.

The displays are designed for a viewing distance up to 6 meters and available in four bright colors. The grey package surface and the evenly lighted untinted segments provide an optimum on-off contrast.

All displays are categorized in luminous intensity groups. That allows users to assemble displays with uniform appearance.

Typical applications include instruments, panel meters, point-of-sale terminals and household equipment.

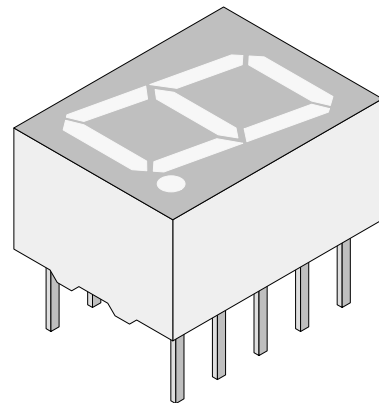

96 11507

### Features

- Evenly lighted segments
- Grey package surface
- Untinted segments
- Luminous intensity categorized
- Yellow and green categorized for color
- Wide viewing angle
- Suitable for DC and high peak current

### Applications

Panel meters  
 Test- and measure- equipment  
 Point-of-sale terminals  
 Control units

## Absolute Maximum Ratings

$T_{amb} = 25^{\circ}\text{C}$ , unless otherwise specified

TDSR315./TDSR316., TDSO315./TDSO316., TDSY315./TDSY316., TDSG315./TDSG316., /

| Parameter                               | Test Conditions                                     | Type          | Symbol     | Value       | Unit               |
|---|---|---------------|------------|-------------|--------------------|
| Reverse voltage per segment or DP       |   |               | $V_R$      | 6           | V                  |
| DC forward current per segment or DP    |   | TDSR315./316. | $I_F$      | 30          | mA                 |
|   |   | TDSO315./316. | $I_F$      | 20          | mA                 |
|   |   | TDSY315./316. | $I_F$      | 20          | mA                 |
|   |   | TDSG315./316. | $I_F$      | 20          | mA                 |
| Surge forward current per segment or DP | $t_p \leq 10 \mu\text{s}$<br>(non repetitive)       | TDSR315./316. | $I_{FSM}$  | 0.5         | A                  |
|   |   | TDSO315./316. | $I_{FSM}$  | 0.15        | A                  |
|   |   | TDSY315./316. | $I_{FSM}$  | 0.15        | A                  |
|   |   | TDSG315./316. | $I_{FSM}$  | 0.15        | A                  |
| Power dissipation                       | $T_{amb} \leq 45^{\circ}\text{C}$                   |               | $P_V$      | 480         | mW                 |
| Junction temperature                    |   |               | $T_j$      | 100         | $^{\circ}\text{C}$ |
| Operating temperature range             |   |               | $T_{amb}$  | -40 to + 85 | $^{\circ}\text{C}$ |
| Storage temperature range               |   |               | $T_{stg}$  | -40 to + 85 | $^{\circ}\text{C}$ |
| Soldering temperature                   | $t \leq 3 \text{ sec}$ , 2mm<br>below seating plane |               | $T_{sd}$   | 260         | $^{\circ}\text{C}$ |
| Thermal resistance LED junction/ambient |   |               | $R_{thJA}$ | 120         | K/W                |

## Optical and Electrical Characteristics

$T_{amb} = 25^{\circ}\text{C}$ , unless otherwise specified

Red (TDSR315., TDSR316.)

| Parameter  | Test Conditions           | Type              | Symbol      | Min | Typ      | Max | Unit           |
|--|---------------------------|-------------------|-------------|-----|----------|-----|----------------|
| Luminous intensity per segment (digit average) <sup>1)</sup> | $I_F = 10 \text{ mA}$     | TDSR<br>3150/3160 | $I_V$       | 180 |          |     | $\mu\text{cd}$ |
| Dominant wavelength  | $I_F = 10 \text{ mA}$     |                   | $\lambda_d$ |     | 655      |     | nm             |
| Peak wavelength  | $I_F = 10 \text{ mA}$     |                   | $\lambda_p$ |     | 660      |     | nm             |
| Angle of half intensity                                      | $I_F = 10 \text{ mA}$     |                   | $\phi$      |     | $\pm 50$ |     | deg            |
| Forward voltage per segment or DP                            | $I_F = 20 \text{ mA}$     |                   | $V_F$       |     | 1.6      | 2   | V              |
| Reverse voltage per segment or DP                            | $I_R = 10 \mu\text{A}$    |                   | $V_R$       | 6   | 15       |     | V              |
| <sup>1)</sup> $I_{Vmin}$ and $I_V$ groups are mean           | values of segments a to g |                   |             |     |          |     |                |

**Orange red (TDSO315. , TDSO316. )**

| Parameter  | Test Conditions           | Type              | Symbol      | Min | Typ      | Max | Unit           |
|--|---------------------------|-------------------|-------------|-----|----------|-----|----------------|
| Luminous intensity per segment (digit average) <sup>1)</sup> | $I_F = 10 \text{ mA}$     | TDSO<br>3150/3160 | $I_V$       | 450 |          |     | $\mu\text{cd}$ |
| Dominant wavelength  | $I_F = 10 \text{ mA}$     |                   | $\lambda_d$ | 612 |          | 625 | nm             |
| Peak wavelength  | $I_F = 10 \text{ mA}$     |                   | $\lambda_p$ |     | 630      |     | nm             |
| Angle of half intensity                                      | $I_F = 10 \text{ mA}$     |                   | $\phi$      |     | $\pm 50$ |     | deg            |
| Forward voltage per segment or DP                            | $I_F = 20 \text{ mA}$     |                   | $V_F$       |     | 2        | 3   | V              |
| Reverse voltage per segment or DP                            | $I_R = 10 \mu\text{A}$    |                   | $V_R$       | 6   | 15       |     | V              |
| <sup>1)</sup> $I_{V\text{min}}$ and $I_V$ groups are mean    | values of segments a to g |                   |             |     |          |     |                |

**Yellow (TDSY315. , TDSY316. )**

| Parameter  | Test Conditions           | Type              | Symbol      | Min | Typ      | Max | Unit           |
|--|---------------------------|-------------------|-------------|-----|----------|-----|----------------|
| Luminous intensity per segment (digit average) <sup>1)</sup> | $I_F = 10 \text{ mA}$     | TDSY<br>3150/3160 | $I_V$       | 450 |          |     | $\mu\text{cd}$ |
| Dominant wavelength  | $I_F = 10 \text{ mA}$     |                   | $\lambda_d$ | 581 |          | 594 | nm             |
| Peak wavelength  | $I_F = 10 \text{ mA}$     |                   | $\lambda_p$ |     | 585      |     | nm             |
| Angle of half intensity                                      | $I_F = 10 \text{ mA}$     |                   | $\phi$      |     | $\pm 50$ |     | deg            |
| Forward voltage per segment or DP                            | $I_F = 20 \text{ mA}$     |                   | $V_F$       |     | 2.4      | 3   | V              |
| Reverse voltage per segment or DP                            | $I_R = 10 \mu\text{A}$    |                   | $V_R$       | 6   | 15       |     | V              |
| <sup>1)</sup> $I_{V\text{min}}$ and $I_V$ groups are mean    | values of segments a to g |                   |             |     |          |     |                |

**Green (TDSG315. , TDSG316. )**

| Parameter  | Test Conditions           | Type              | Symbol      | Min | Typ      | Max | Unit           |
|--|---------------------------|-------------------|-------------|-----|----------|-----|----------------|
| Luminous intensity per segment (digit average) <sup>1)</sup> | $I_F = 10 \text{ mA}$     | TDSG<br>3150/3160 | $I_V$       | 450 |          |     | $\mu\text{cd}$ |
| Dominant wavelength  | $I_F = 10 \text{ mA}$     |                   | $\lambda_d$ | 562 |          | 575 | nm             |
| Peak wavelength  | $I_F = 10 \text{ mA}$     |                   | $\lambda_p$ |     | 565      |     | nm             |
| Angle of half intensity                                      | $I_F = 10 \text{ mA}$     |                   | $\phi$      |     | $\pm 50$ |     | deg            |
| Forward voltage per segment or DP                            | $I_F = 20 \text{ mA}$     |                   | $V_F$       |     | 2.4      | 3   | V              |
| Reverse voltage per segment or DP                            | $I_R = 10 \mu\text{A}$    |                   | $V_R$       | 6   | 15       |     | V              |
| <sup>1)</sup> $I_{V\text{min}}$ and $I_V$ groups are mean    | values of segments a to g |                   |             |     |          |     |                |

Typical Characteristics ( $T_{amb} = 25^{\circ}\text{C}$ , unless otherwise specified)

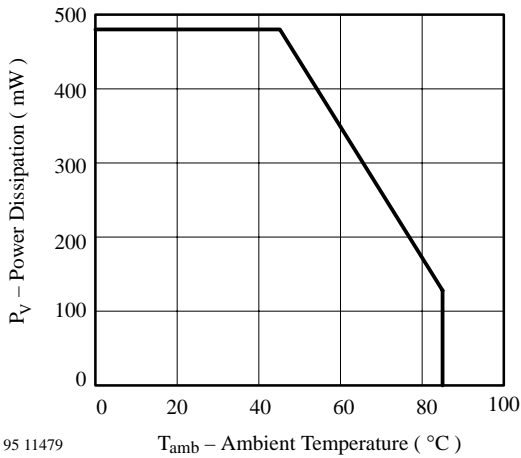

95 11479  $T_{amb}$  – Ambient Temperature ( $^{\circ}\text{C}$ )  
Figure 1. Power Dissipation vs. Ambient Temperature

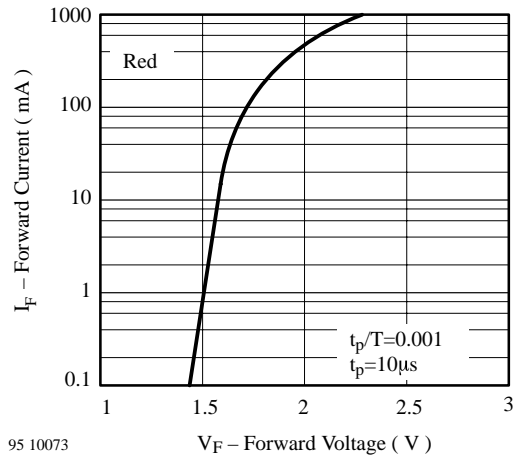

95 10073  $V_F$  – Forward Voltage (V)  
Figure 4. Forward Current vs. Forward Voltage

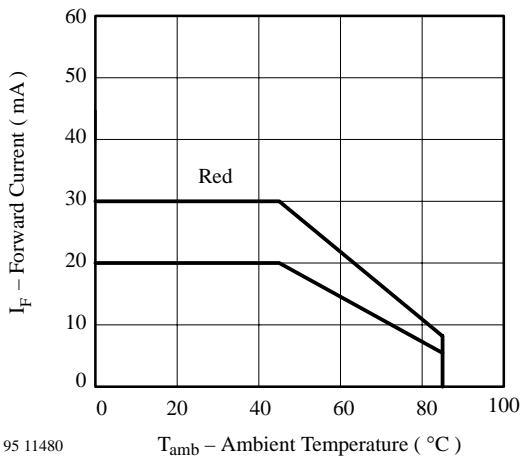

95 11480  $T_{amb}$  – Ambient Temperature ( $^{\circ}\text{C}$ )  
Figure 2. Forward Current vs. Ambient Temperature

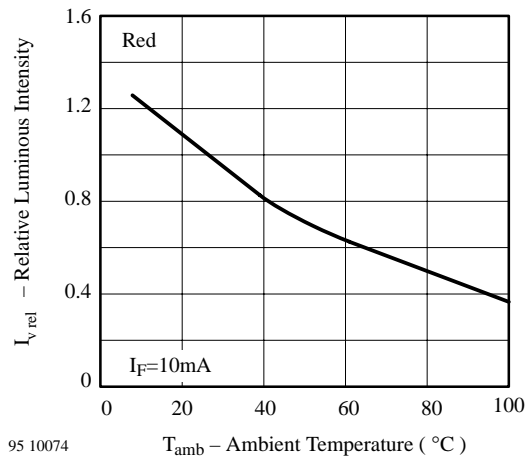

95 10074  $T_{amb}$  – Ambient Temperature ( $^{\circ}\text{C}$ )  
Figure 5. Rel. Luminous Intensity vs. Ambient Temperature

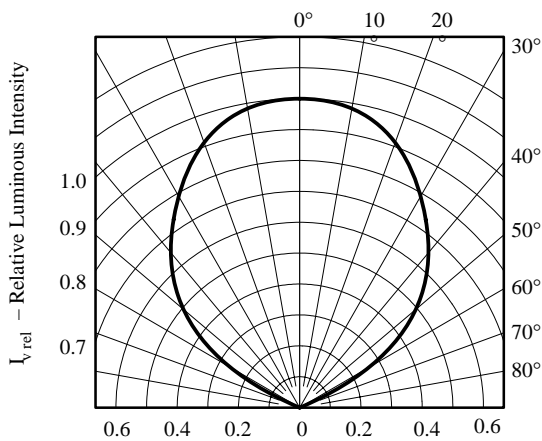

95 10082  
Figure 3. Rel. Luminous Intensity vs. Angular Displacement

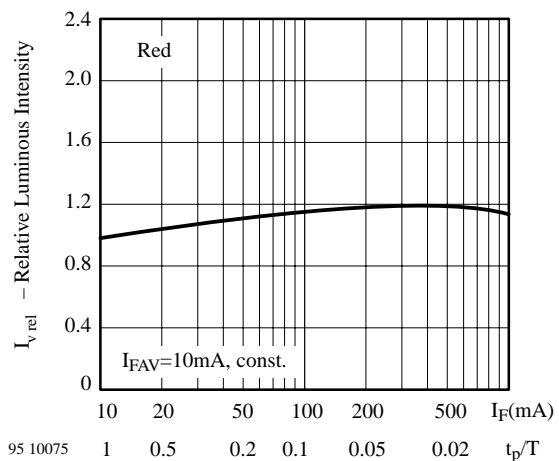

95 10075  
Figure 6. Rel. Lumin. Intensity vs. Forw. Current/Duty Cycle

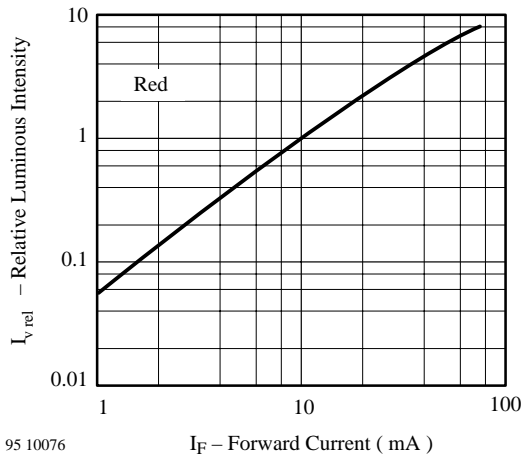

Figure 7. Relative Luminous Intensity vs. Forward Current

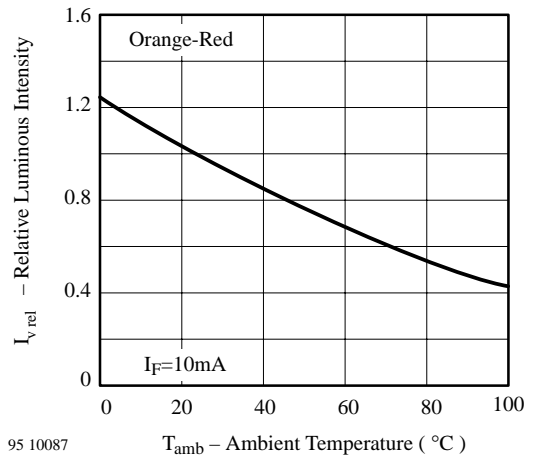

Figure 10. Rel. Luminous Intensity vs. Ambient Temperature

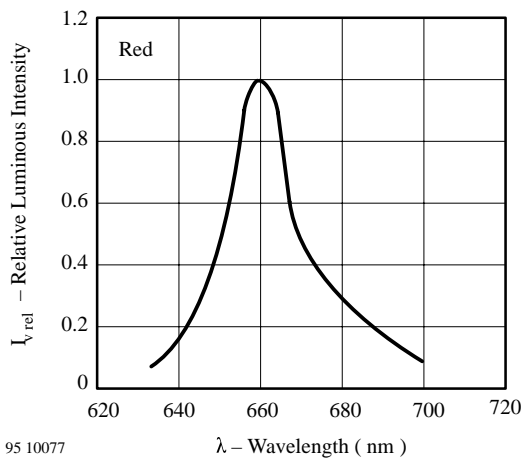

Figure 8. Relative Luminous Intensity vs. Wavelength

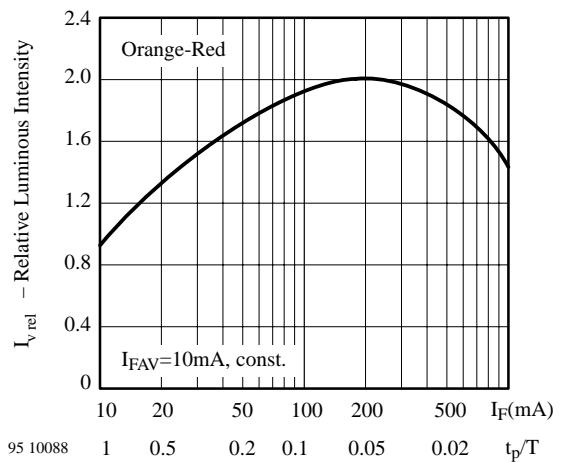

Figure 11. Rel. Lumin. Intensity vs. Forw. Current/Duty Cycle

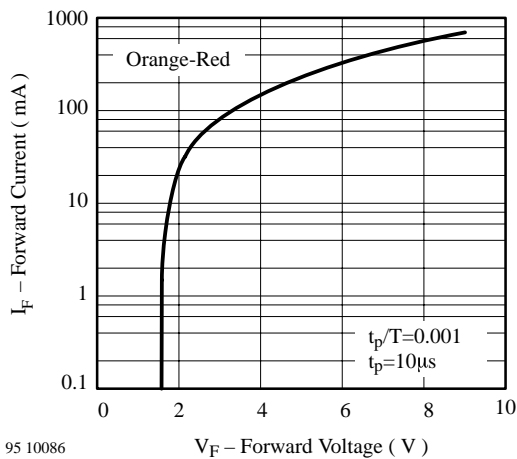

Figure 9. Forward Current vs. Forward Voltage

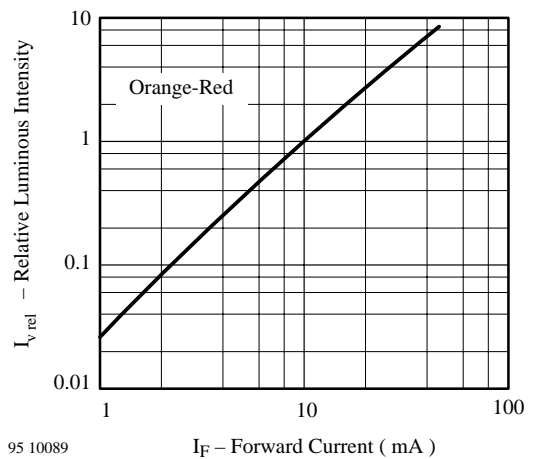

Figure 12. Relative Luminous Intensity vs. Forward Current

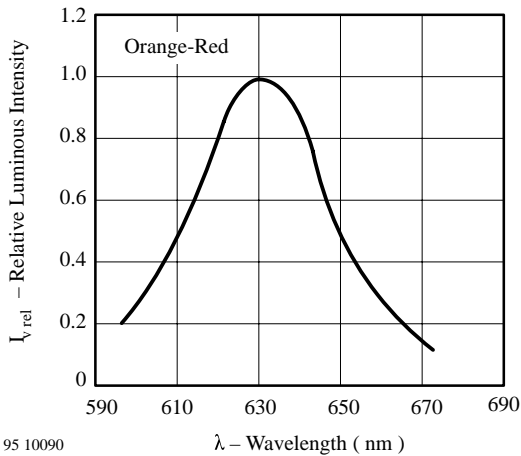

Figure 13. Relative Luminous Intensity vs. Wavelength

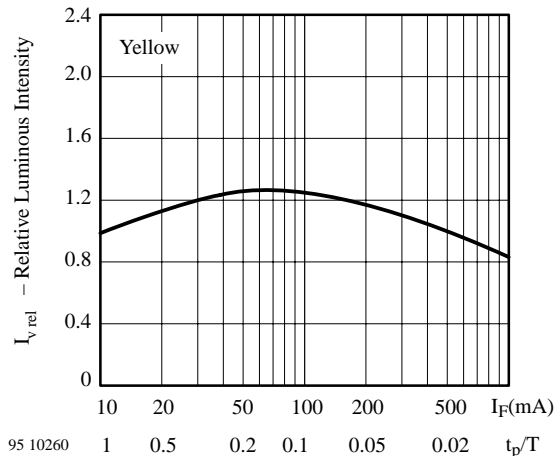

Figure 16. Rel. Lumin. Intensity vs. Forw. Current/Duty Cycle

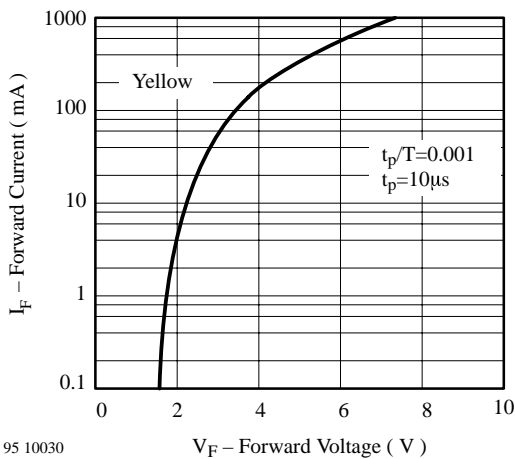

Figure 14. Forward Current vs. Forward Voltage

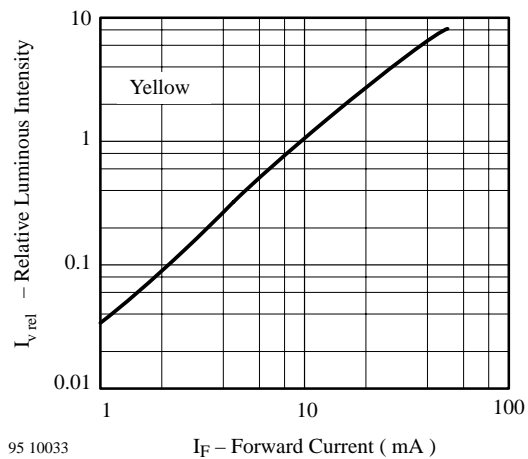

Figure 17. Relative Luminous Intensity vs. Forward Current

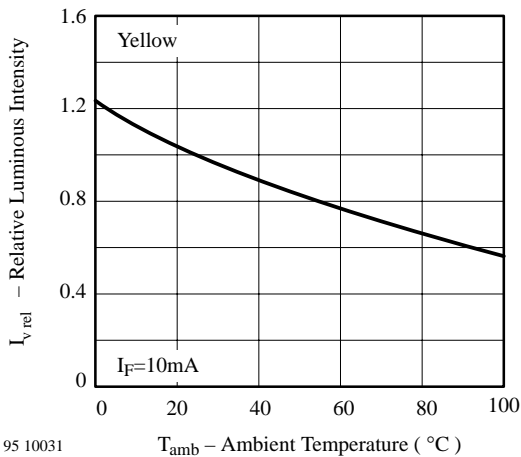

Figure 15. Rel. Luminous Intensity vs. Ambient Temperature

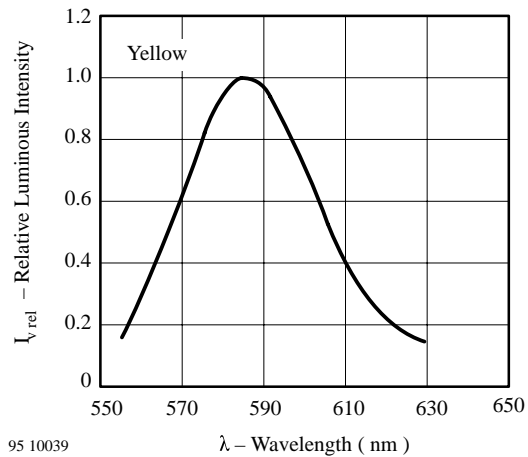
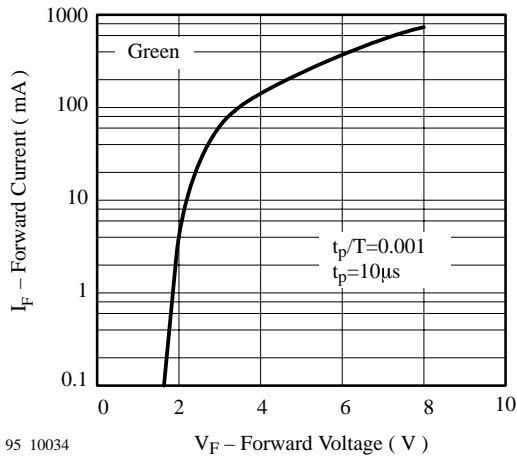
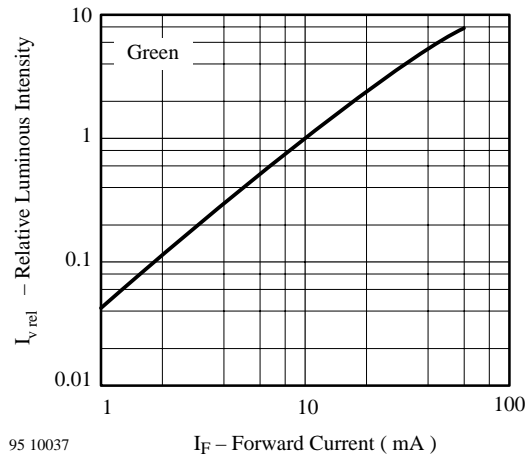

Figure 18. Relative Luminous Intensity vs. Wavelength



95 10034  
Figure 19. Forward Current vs. Forward Voltage



95 10037  
Figure 22. Relative Luminous Intensity vs. Forward Current

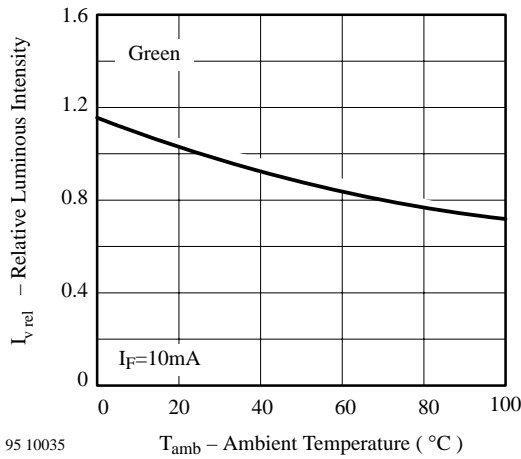

95 10035  
Figure 20. Rel. Luminous Intensity vs. Ambient Temperature

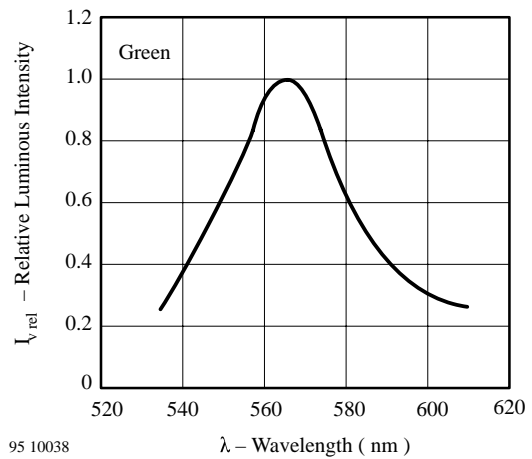

95 10038  
Figure 23. Relative Luminous Intensity vs. Wavelength

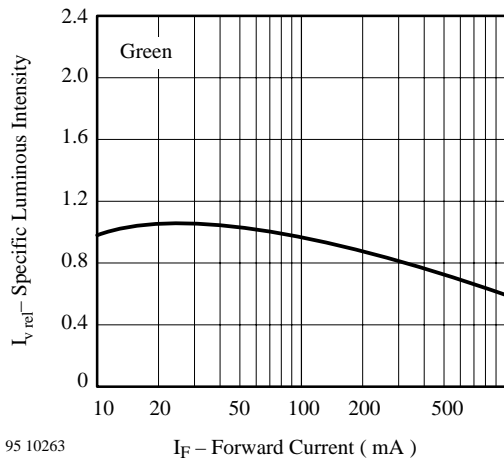

95 10263  
Figure 21. Specific Luminous Intensity vs. Forward Current

Dimensions in mm

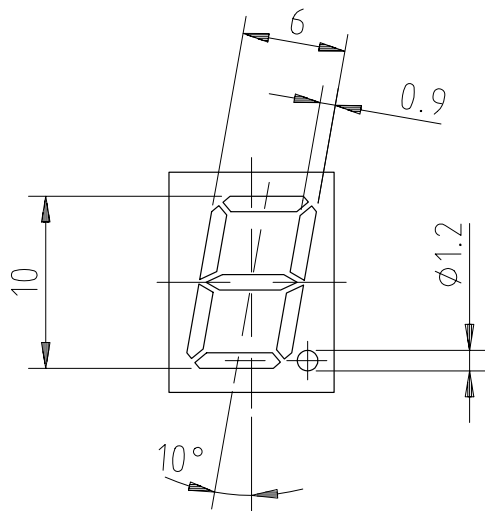
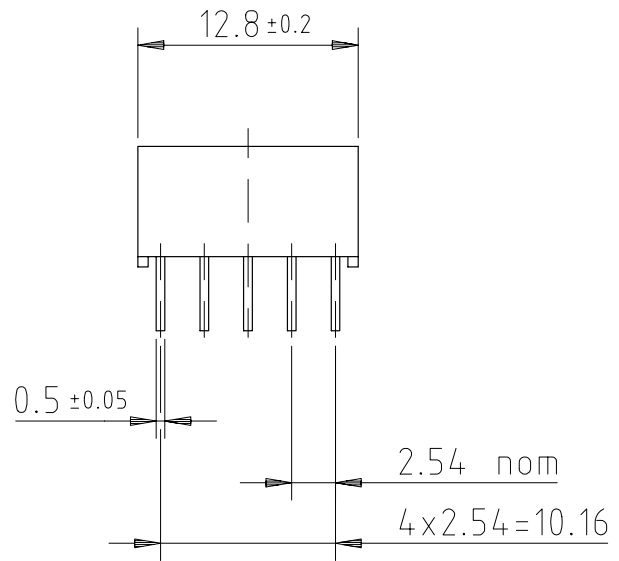
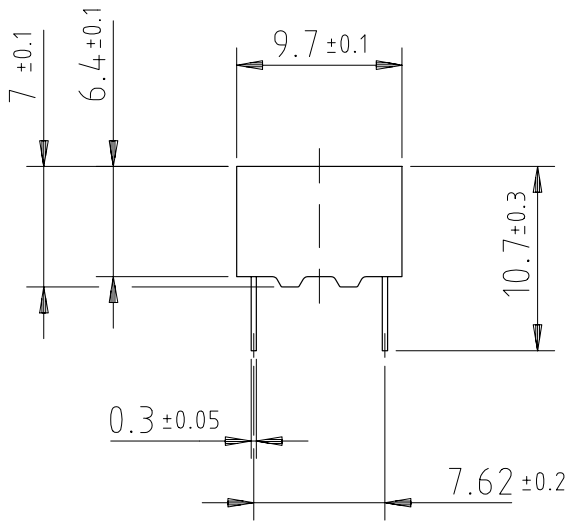

95 11343

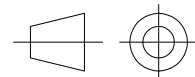

technical drawings according to DIN specifications

Pin connections

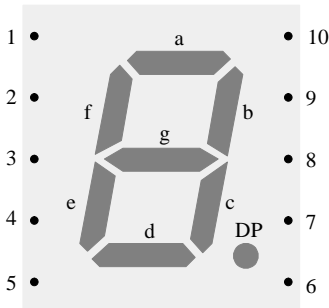

- 1 fg
- 2 f
- 3 A (C)
- 4 e
- 5 d
- 6 DP
- 7 c
- 8 A (C)
- 9 b
- 10 a

96 11678



## **Ozone Depleting Substances Policy Statement**

It is the policy of **Vishay Semiconductor GmbH** to

1. Meet all present and future national and international statutory requirements.
2. Regularly and continuously improve the performance of our products, processes, distribution and operating systems with respect to their impact on the health and safety of our employees and the public, as well as their impact on the environment.

It is particular concern to control or eliminate releases of those substances into the atmosphere which are known as ozone depleting substances (ODSs).

The Montreal Protocol (1987) and its London Amendments (1990) intend to severely restrict the use of ODSs and forbid their use within the next ten years. Various national and international initiatives are pressing for an earlier ban on these substances.

**Vishay Semiconductor GmbH** has been able to use its policy of continuous improvements to eliminate the use of ODSs listed in the following documents.

1. Annex A, B and list of transitional substances of the Montreal Protocol and the London Amendments respectively
2. Class I and II ozone depleting substances in the Clean Air Act Amendments of 1990 by the Environmental Protection Agency (EPA) in the USA
3. Council Decision 88/540/EEC and 91/690/EEC Annex A, B and C (transitional substances) respectively.

**Vishay Semiconductor GmbH** can certify that our semiconductors are not manufactured with ozone depleting substances and do not contain such substances.

**We reserve the right to make changes to improve technical design and may do so without further notice.**

Parameters can vary in different applications. All operating parameters must be validated for each customer application by the customer. Should the buyer use Vishay-Telefunken products for any unintended or unauthorized application, the buyer shall indemnify Vishay-Telefunken against all claims, costs, damages, and expenses, arising out of, directly or indirectly, any claim of personal damage, injury or death associated with such unintended or unauthorized use.

Vishay Semiconductor GmbH, P.O.B. 3535, D-74025 Heilbronn, Germany  
Telephone: 49 (0)7131 67 2831, Fax number: 49 (0)7131 67 2423